

PROLINE 80

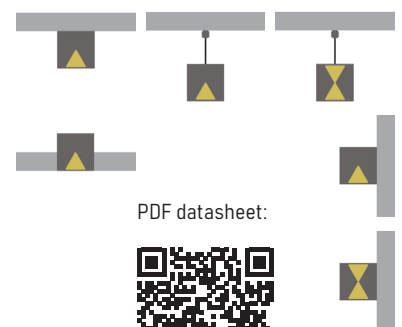

Linear luminaire made of extruded aluminum profile. High luminous efficacy optics with selection of diffusers. Direct or direct/indirect lighting type. Top quality SMD LED modules with colour consistency MacAdams ≤ 3 , extensive portfolio of lumen ranges, CCTs and spectra. Variety of drivers: standard EVG on/off, DALI and wireless controlled as MasterConnect or Casambi on request. Built-in or remote, wireless occupancy & daylight sensor available to allow significant energy savings and wireless connectivity. Mounting type: surface mounted, wall mounted, suspended, trimless recessed (custom made ceiling brackets on request). Standard colour RAL 9003S, any other colour from basic RAL range available at no extra cost. Variety of diffusers, lumen outputs and drivers allows to use this luminaire in different types of lighting projects. Wide selection of standard lengths: single linear luminaires (type S) or system luminaires (type SE/M) and system connectors (L,T,X type). Many lengths of lighting lines, square and rectangular shapes can be created by using our system pieces. End caps for single (S type) profiles included. All accessories such as end caps, linear connectors, quick connectors, suspension wires or power cables for system profiles (SE/M type) or TR mounting brackets (for TR version) should be ordered separately. Bespoke lengths and shapes of lighting lines available on request. Luminous flux & Luminaire Power tolerance up to 10%. System power consumption depends on components used. Luminous efficacy depends on type of LED's, electronics, optics and diffuser. The most up to date technical parameters can be found on our website and in database of LDT files.

Lighting direction:



PDF datasheet:



PROLINE 80

Mounting:	Surface mounted, suspended, wall mounted, trimless recessed
Body material:	Aluminium profile
Colour:	Standard white RAL 9003M, other RAL colours on request
Lumen output:	Standard up to 4000 lm/meter, any other on request
LED module:	Signify (Philips), Tridonic or equivalent SMD LED modules
Colour temperature:	3000/4000K/2700-6500K TW other on request
Colour Rendering:	CRI>80 in standard, other on request
Driver:	EVG on-off/DALI/TW DT8/MC (MasterConnect)/Casambi, other on request
Wireless control:	Philips MasterConnect / Casambi, other on request
Daylight/Occupancy sensor:	Built-in XC sensor or wireless MCS sensor
Emergency unit:	On request
Operating temperature range:	0°C ... +35°C
IP Class:	IP20 in standard
Power:	220-240V 50/60Hz
Lighting direction:	Direct, direct / indirect lighting
Light distribution:	Symmetric
Diffusor:	OP white acrylic / MP19H microprismatic UGR<19
Optics:	White reflector
Beam angle:	All types available in our LDT file database
Warranty:	5 Years standard warranty

- PROLINE 80 S DN** single profile, ceiling mounted or suspended, light down, OP or MP19H diffusor
- PROLINE 80 S UP_DN** single profile, suspended, light up & down, OP or MP19H diffusor
- PROLINE 80 SE DN** system profile START/END type, ceiling mounted or suspended, light down, OP or MP19H diffusor
- PROLINE 80 SE UP_DN** system profile START/END type, suspended, light up & down, OP or MP19H diffusor
- PROLINE 80 M DN** system profile MIDDLE type, ceiling mounted or suspended, light down, OP or MP19H diffusor
- PROLINE 80 M UP_DN** system profile MIDDLE type, suspended, light up & down, OP or MP19H diffusor
- PROLINE 80 L / T / X DN** system profile L/T/X type, ceiling mounted or suspended, light down, OP or MP19H diffusor
- PROLINE 80 L / T / X UP_DN** system profile L/T/X type, suspended, light up & down, OP or MP19H diffusor
- PROLINE 80 S DN WL** single profile, wall mounted, light down, OP or MP19H diffusor
- PROLINE 80 S UP_DN WL** single profile, wall mounted, light up & down, OP or MP19H diffusor
- PROLINE 80 TR S DN** single profile, trimless recessed, light down, OP or MP19H diffusor

All current index numbers, lumen outputs, power consumption and many other technical information are available in our 2024 pricelist. Details on wireless lighting control systems on page number 896.



XCS wireless switch



MCS wireless daylight&occ sensor



XC daylight&occ sensor

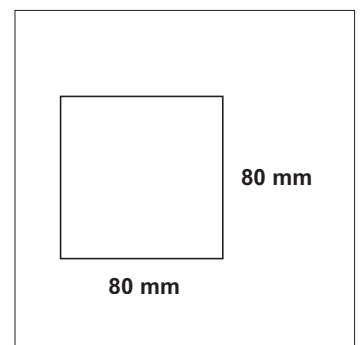

80 mm
80 mm

Basic dimensions

PROLINE 80



OP white acrylic diffuser



MP19H microprismatic diffuser



Trimless mounting available for all types



TR REC BOX 60 trimless mounting system

All PROLINE type luminaires can be made to measure as single lighting lines or lighting systems in different sizes and shapes. Please contact our sales team for details.

Mounting types:

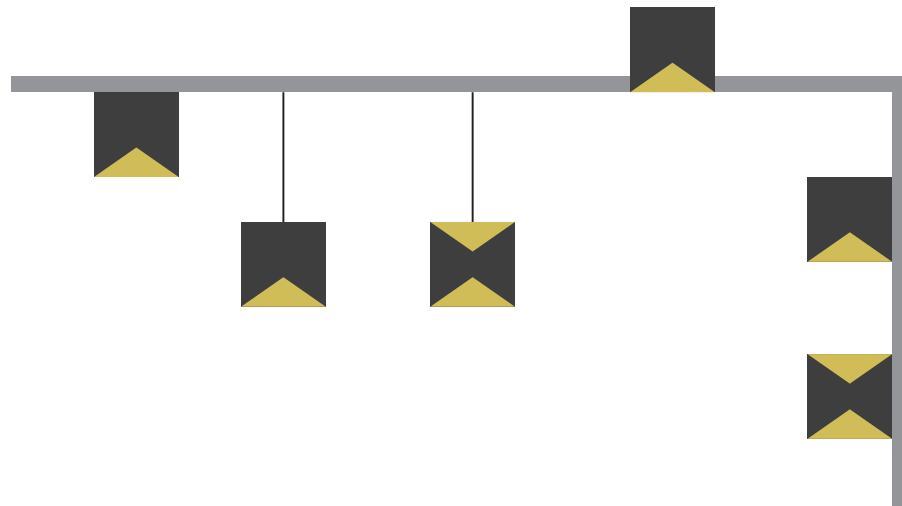

PROLINE 80

Accessories:



Suspension for PROLINE 80 - 1,5 m long steel wire (1 piece)



3 or 5 core transparent power feed, 1,5 m including ceiling base

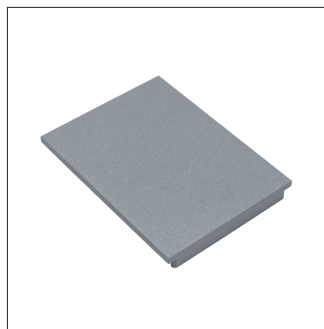

End cap for PROLINE 80 (1 piece)



TR REC BOX 80 - steel box for plasterboard ceiling trimless mounting

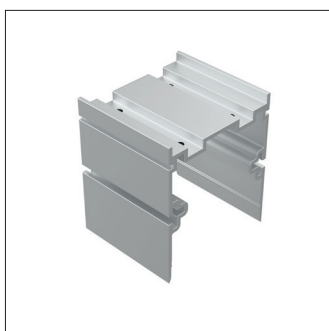

Linear connector for PROLINE 80



3 pole quick connectors (Male + Female)

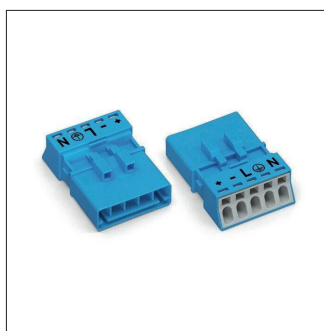

5 pole quick connectors (Male + Female)

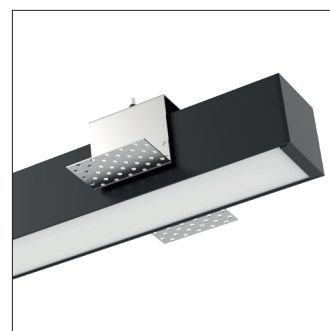

TR (trimless) mounting bracket

All accessories for system profiles and couplers (Type SE / M / L / T / X) such as end caps, linear connectors, quick connectors, suspension wires or power cables should be ordered separately.

Accessories for single profiles (Type S) such as suspension wires or power cables should be ordered separately. End caps for single profiles are included in product's index numbers.

Couplers:

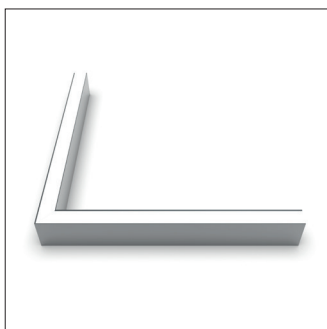

PROLINE 80 system coupler type L DN or UP_DN

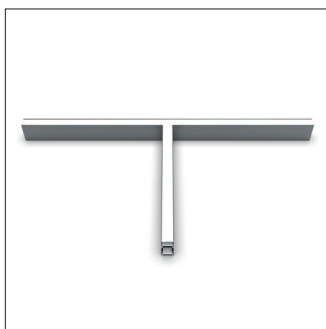

PROLINE 80 system coupler type T DN or UP_DN

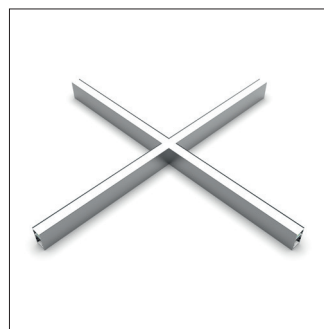

PROLINE 80 system coupler type X DN or UP_DN

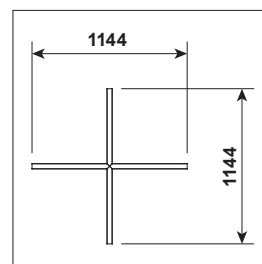
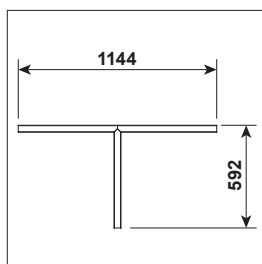
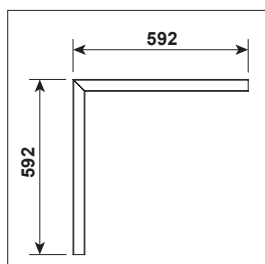

PROLINE 80

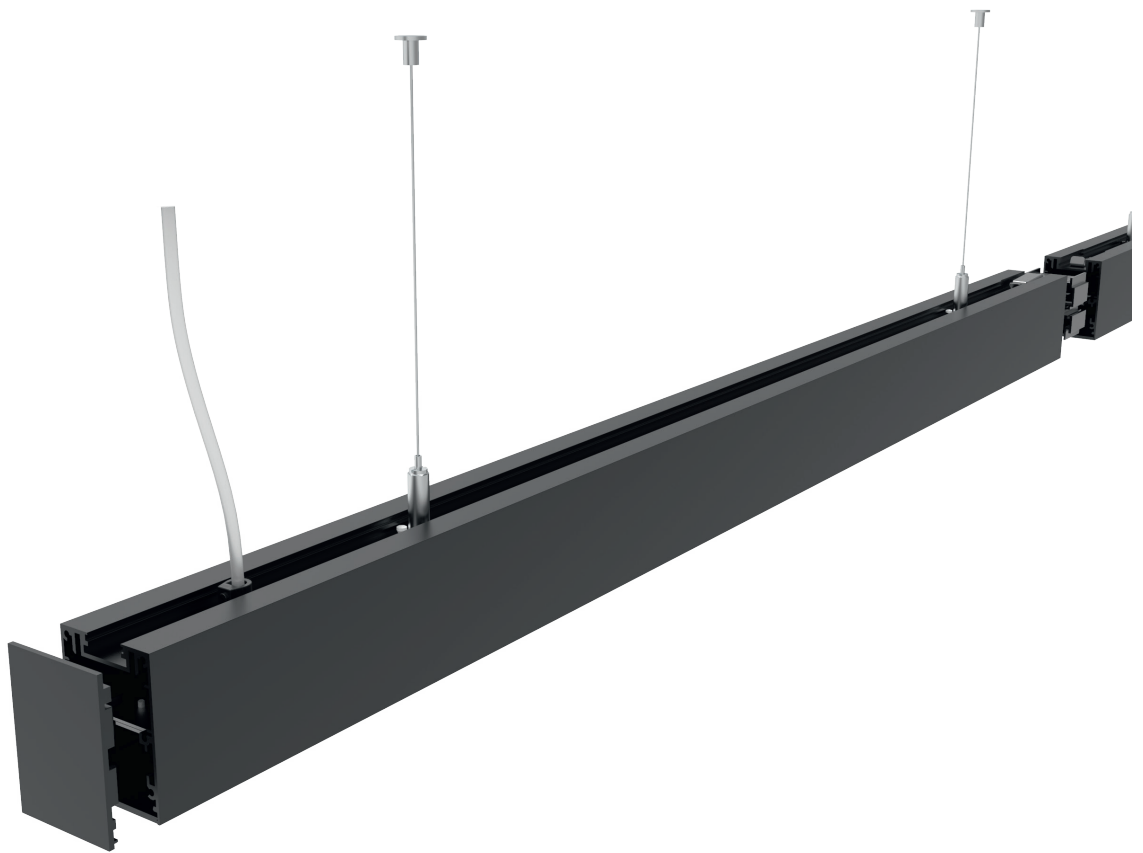
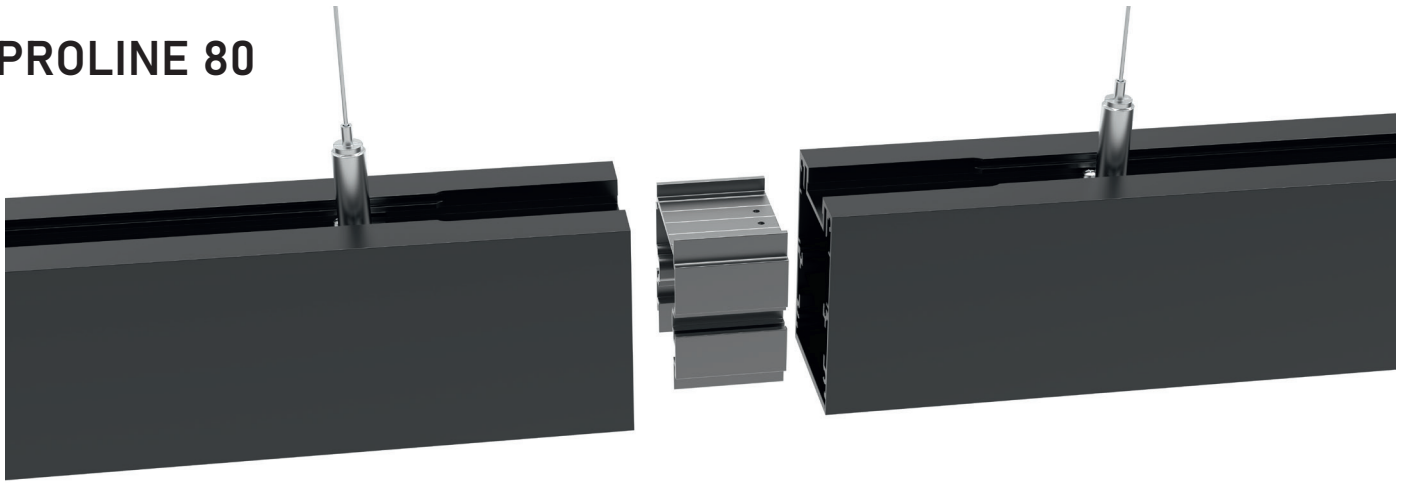

Technical information:

- OP - White acrylic diffuser with over 85% of light transmission to provide high class lighting efficacy.
- MP19H - UGR<19 diffuser solution with extra layer of white acrylic film that provide comfortable lighting from any angle.
- XC - Built-in daylight&occupancy sensor available with all types of profile luminaires.
- MCS - Wireless daylight&occupancy sensor available with all types of profile luminaires.
- XCS - Wireless power switch with dimming and scene setup option.
- TR - Trimless mounting bracket for plasterboard ceiling type - can be custom made depending on ceiling type used.
- TR REC BOX - Trimless mounting box for plasterboard ceiling type - can be custom made depending on ceiling type used.



Energy saving MasterConnect wireless lighting control system with daylight and movement detection technology on request.



PROLINE 80

Profile types:

Single profile versions:

TYPE S DN single profile, light down



MOUNTING OPTIONS:

light down, surface mounted
light down, suspended
light down, wall mounted
light down, trimless recessed

TYPE S UP_DN single profile light up/down



MOUNTING OPTIONS:

light up & down, suspended
light up & down, wall mounted

System profile versions:

TYPE SE DN system profile, start/end section, light down



MOUNTING OPTIONS:

light down, surface mounted
light down, suspended
light down, trimless recessed

TYPE SE UP_DN system profile, start/end section, light up & down



MOUNTING OPTIONS:

light up & down, suspended

TYPE M DN system profile, middle section, light down



MOUNTING OPTIONS:

light down, surface mounted
light down, suspended
light down, trimless recessed

TYPE M UP_DN system profile, middle section, light up & down



MOUNTING OPTIONS:

light up & down, suspended

PROLINE 80

Single profile, standard lengths including end caps TYPE S DN and TYPE S UP_DN:

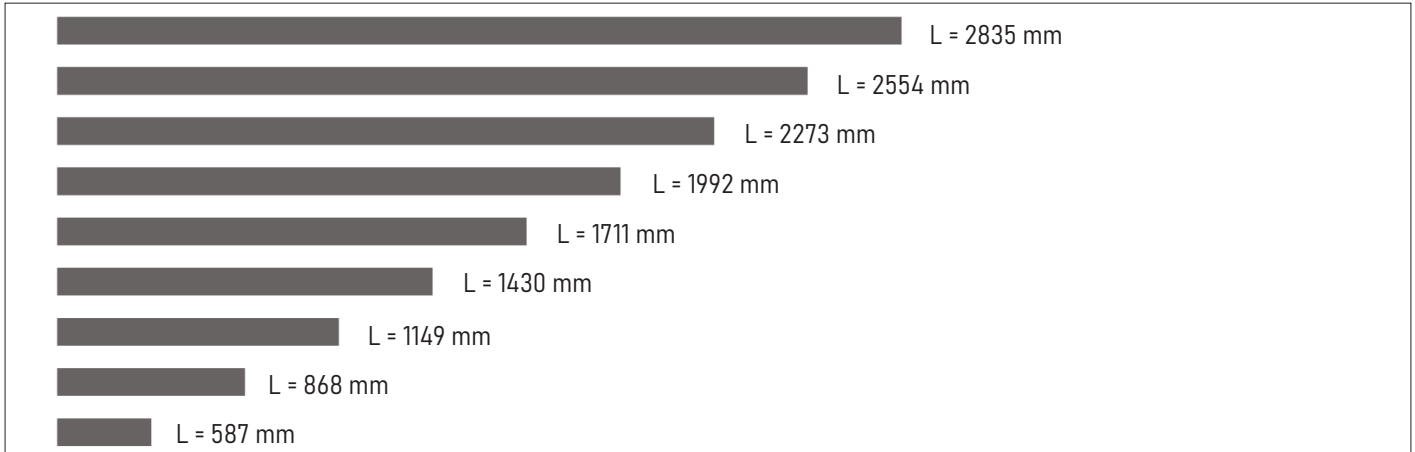

System profile, start/end section lengths including one end cap TYPE SE DN and TYPE SE UP_DN:

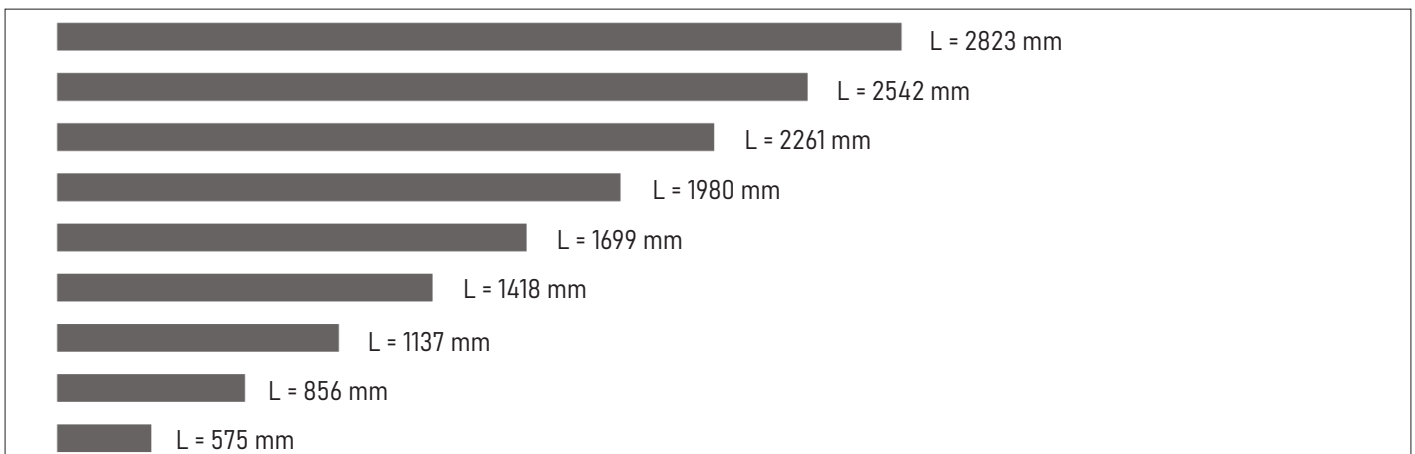

System profile, middle section lengths TYPE M DN and TYPE M UP_DN:

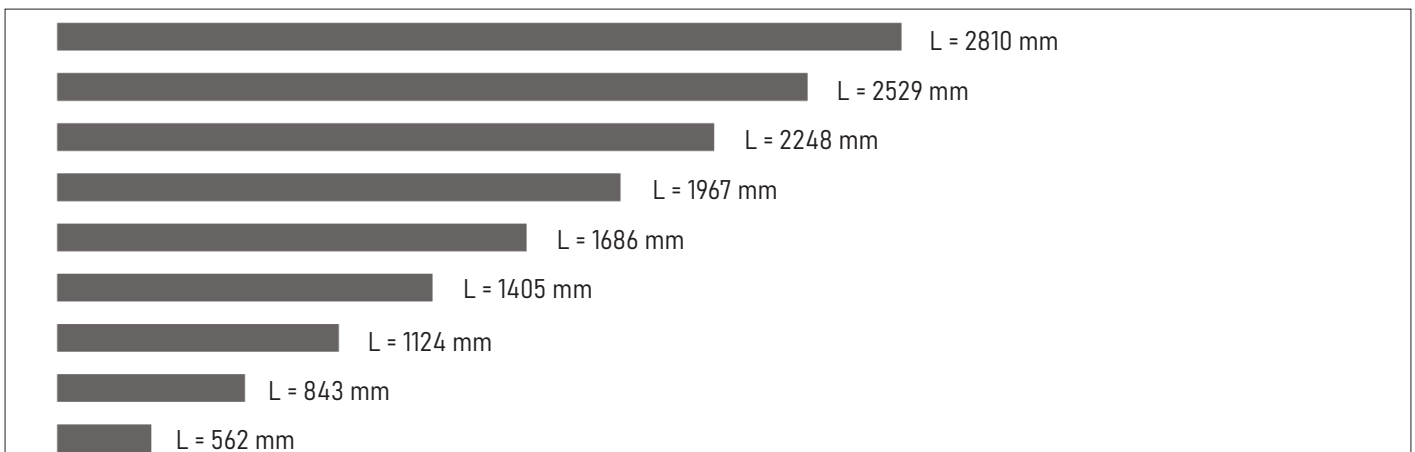

PROLINE 80

DESCRIPTION OF PROLINE CONCEPT:

- PROLINE S DN - single luminaires with light down (can't be connected into lighting systems)
- PROLINE S UP/DN - single luminaires with light up/down (can't be connected into lighting systems)
- PROLINE SE DN - system luminaire with light down (must be used at the beginning and at the end of each linear lighting system)
- PROLINE SE UP/DN - system luminaire with light up/down (must be used at the beginning and at the end of each linear lighting system)
- PROLINE M DN - system luminaire with light down (middle section to be used in between SE type profiles). Any length of lighting system can be created by using different lengths and numbers of M-type profiles between two SE-type profiles.
- PROLINE M UP/DN - system luminaire with light up/down (middle section to be used in between SE-type profiles). Any length of lighting system can be created by using different lengths and numbers of M-type profiles between two SE-type profiles.

PROLINE S



PROLINE SE



PROLINE SE



PROLINE SE



PROLINE M



PROLINE SE



PROLINE SE



PROLINE M



PROLINE M



PROLINE M



PROLINE SE

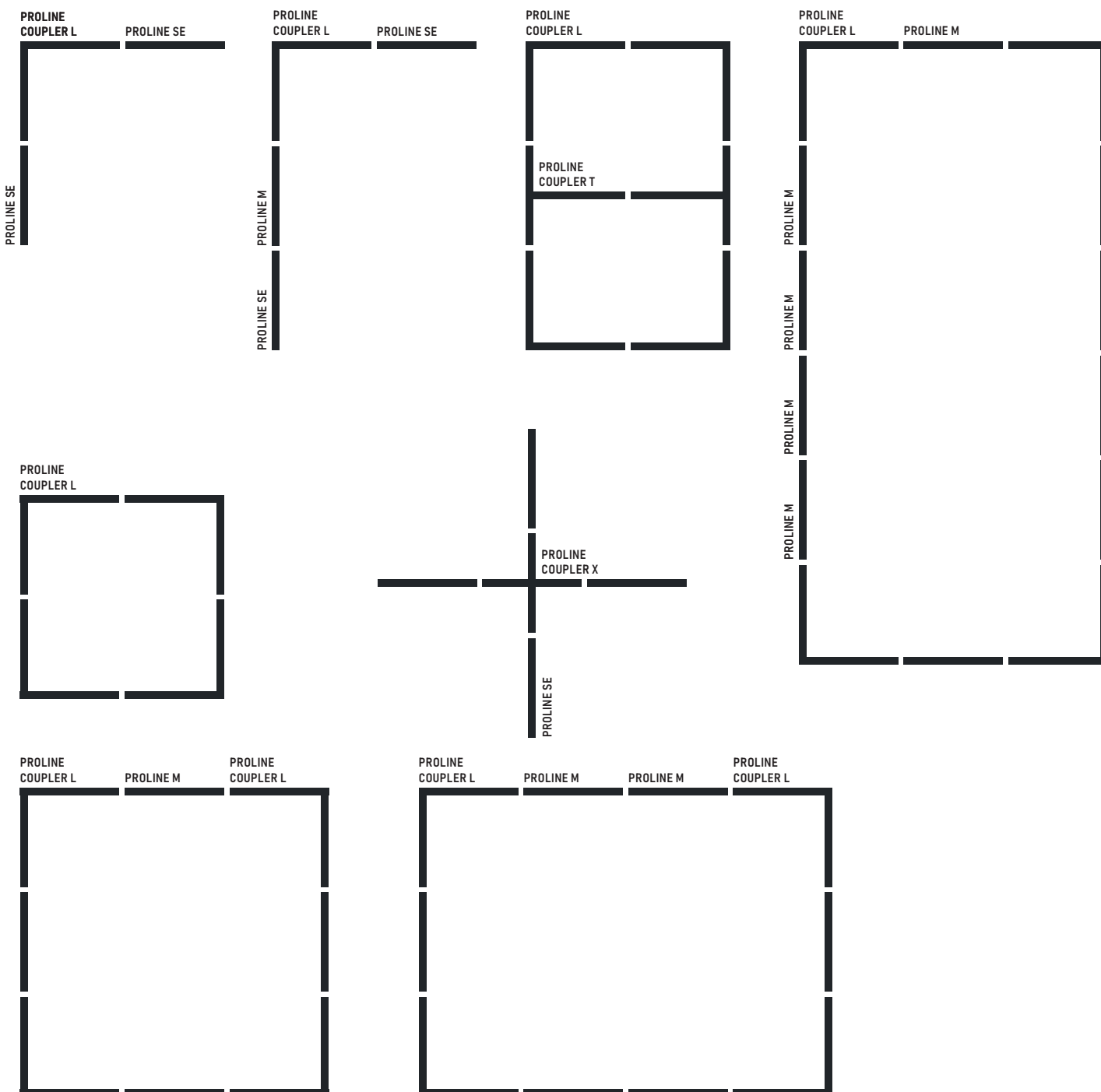

PROLINE 80

PROLINE CONCEPT - HOW TO BUILD LIGHTING SYSTEMS:

- Always start your linear lighting system with SE type of PROFILE
- Use required number of M type PROFILES to extend length of your lighting system
- Always finish your linear lighting system with SE type of PROFILE
- COUPLERS T, X and L type can be used to modify your lighting system design
- Each end of T, X or L COUPLER must be connected further to M or SE type of PROFILE.
- End of COUPLER can't be closed with end cap directly.
- Remember - PROLINE M can't exist on its own without additional SE type of PROFILES.
- Available length of PROLINE elements (SE/M can be found on corresponding pages in our catalogue)
- All accessories such as end caps, linear connectors, quick connectors, suspension wires or power cables should be ordered separately for all types of system profiles: Type SE / M / L / X / T.
- Accessories such as suspension wires or power cables should be ordered separately for all types of single profiles: Type S (end caps are included).

